

tangent

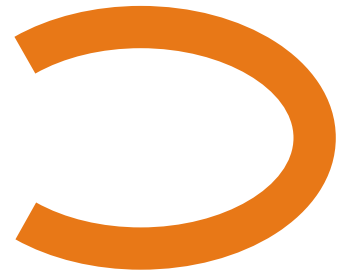

Instruction Manual DVD Recorder



DVD + ReWritable



Table of Contents

Table of Contents	1	Using the On-screen Display	26
Safety Precautions	2	Setting the Parental Lock	27
Important Safety Notices	3	Customizing DVD Function Settings	28
Important Information	5	Recording Options	28
Playable and Recordable Discs	6	Channel Search	29
Disc Protection	7	Normal Recording	29
Identification of Controls	8	One-Touch Record	30
The remote control	10	Time Record	31
Connection	11	Editing	32
Mp3	15	Editing a Title of DVD+RW	32
Playing Back a Disc	16	Editing a Disc of DVD+RW or DVD+R	35
Playing a Normal Disc	16	Specifications	36
Playing a DVD+RW or DVD+R Disc	17	Trouble Shooting Guide	37
General Features	17		
Locating a Specific Title,			
Chapter or Track	19		
Playing Repeatedly	21		
Playing in Random Order	22		
Selecting Camera Angles, Languages			
& Audio Settings	23		
Playing in a favorite Order	24		
Selecting Subtitles	25		

Safety Precautions

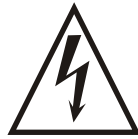

A triangle with a lightning symbol draws the user's attention to "dangerous voltage" without insulation in the housing which may be high enough to entail a risk of electric shock.



A triangle with an exclamation mark draws the user's attention to important instructions for use and maintenance in the accompanying manual which should be studied.



Symbol for Class II (double insulation).

WARNING: TO MINIMISE THE RISK OF FIRE AND ELECTRIC SHOCK, DO NOT EXPOSE DEVICE TO RAIN OR MOISTURE. DO NOT OPEN THE HOUSING AS IT CONTAINS DANGEROUS VOLTAGE. ONLY SKILLED TECHNICIANS ARE ALLOWED TO CARRY OUT REPAIR AND SERVICE.

CAUTION: If the power cord plug is to be replaced, it is important that the replacement is identical to the plug to be replaced, or that the new plug has been recommended by the manufacturer.

TO AVOID THE RISK OF ELECTRIC SHOCK, IT IS IMPORTANT TO INSERT THE PLUG CORRECTLY INTO THE SOCKET.

This DVD player includes a laser system.

There is a risk of dangerous radiation from the laser beam if buttons, controls and procedures are not used or carried out as described in this manual. To avoid contact with the laser beam, do not open the device.

DO NOT LOOK DIRECTLY INTO THE LASER BEAM.

Important Safety Notices

WARNING: IT IS IMPORTANT THAT YOU STUDY AND OBSERVE BOTH THE INSTRUCTIONS IN THIS MANUAL AND THE INSTRUCTIONS ON THE DEVICE. KEEP THIS MANUAL FOR FUTURE USE.

This device was developed and made with a view to providing maximum safety for the user. Incorrect use of the device may cause electric shock or fire. The protection built into this device will protect the user if the procedure below is observed in connection with installation, use and repair. This device is fully electronic and contains no parts which can be repaired by the user.

THE HOUSING MUST NOT BE REMOVED. RISK OF DANGEROUS VOLTAGE. ONLY SKILLED TECHNICIANS ARE ALLOWED TO REPAIR THE DEVICE.

Read the manual

On unpacking the device, please read the manual carefully and observe all instructions given.



Heat

Do not place the device near sources of heating such as radiator, register, stove or other heat-producing devices (including amplifiers).



Power supply

Only the power supply indicated on the rating plate must be used for this device. If you are not sure which power supply you have, please contact the distributor or the local electricity supplier.



Water and moisture

The device must not be placed close to water, such as bath tub, wash basin, kitchen sink or wash tub, in a damp cellar or close to a swimming pool, etc.

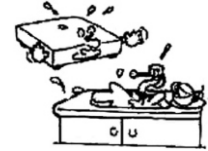

Earthing or polarization

If the plug cannot be inserted properly into the socket, or if the plug does not fit, the device must not be used in your country.

Cleaning

Unplug the device before cleaning. Do not use liquid detergents and aerosol cleaning agents. Use a dry cloth.



Ventilation

The housing is provided with slots and openings to ensure ventilation and reliable operation and protect the device against overheating. Do not block or cover these openings. The openings must never be blocked, for example by placing the device on a bed, a sofa, a carpet or similar surface.

Power cords

Wiring must be organised to prevent people from stepping on the cables and to avoid pinching by objects placed on or beside them. Take special care around sockets and plug boxes and where the cable leaves the device.



Overloading

Make sure that sockets, extension flexes and plug boxes are not overloaded as this may lead to fire or electric shock.



Important Safety Notices

Lightning

Unplug the device for additional protection during thunder or when the device is not used for prolonged periods. This will prevent damage to the device from lightning and surges.



Discs

Do not use scratched, deformed or repaired discs. Such discs will break easily and may cause serious injury and damage to the device.



Penetration of objects and liquid

Never push any objects through the openings into the device, as they may touch dangerous voltage points or short circuit parts and cause fire or electric shock. Do not spill liquid on the DVD player.



Damage

Unplug the device and contact skilled technicians in the following cases:

- A) If power cord or plug is damaged.
- B) If liquid has been spilled on the device or objects have fallen into the device.
- C) If the device has been exposed to rain or water.
- D) If the device does not work properly after adhering to the instructions in the user manual. Make only the setups mentioned in the manual, as incorrect setup may cause damage and will often make it difficult for a skilled technician to make the device work properly again.
- E) If the device has been dropped or damaged in any other way.
- F) When the operation of the device changes drastically, the device requires service.

Accessories

The device must not be placed on unstable surfaces such as a trolley, stand, tripod, shelf or table. The device may fall and injure children or adults or be damaged. Use only trolley, stand, tripod, shelf or table which are very stable or provided with the device. The Device must be installed in accordance with the manufacturer's instructions and by means of installation equipment recommended by the manufacturer. If the device is placed on a trolley, the trolley must be moved carefully. Sudden stops, unnecessary force and uneven surfaces may cause the trolley to turn over.



Service

Do not attempt to carry out any service work yourself. By opening or removing the housing, you will be exposed to dangerous voltage, etc. Any service work should be carried out by skilled technicians.



Disc drive

Keep your hands off the drive when it closes to avoid trapping your fingers.



Loads

Do not place heavy loads on the DVD player, and do not step on it. The load may fall and cause serious injury or damage to the device.



Spare parts

If spare parts are required, make sure that the technician uses spare parts specified by the manufacturer or with the same characteristics as the original component. Unauthorised spare parts may cause fire, electric shock, etc.

Safety check

After service or repairs on the DVD player, ask the service technician to carry out a safety check to ensure that the device is ready for use.



Important Information

Handling instructions

- The DVD player's top and back panel may become warm after prolonged use. This is not due to a defect.
- When the DVD player is not used, remove the disc and turn off the device.
- If the DVD player is not used for a long period, its function may deteriorate. Therefore, the DVD player should be turned on and used now and then.

Protect the power cord

Follow the instructions below to avoid irregular function, electric shock, fire, or injury:

- Hold the plug firmly when inserting it into the socket
- Avoid heat-producing devices
- Do not place objects on the power cord
- Do not carry out service work on or change the power cord

Positioning

Do not place the device in any of the following places:

- In sunlight, close to heat-producing devices and in a closed trolley
- At high temperatures (40°C or above) or high relative humidity (90% or more)
- In dirty places as some internal parts may be damaged

Do not put your fingers or any other objects into the device

- Touching the internal parts is dangerous and may cause injury or damage. Do not open the housing.
- Do not place foreign matter on the drive.

Interference

Placing the DVD player near a television set, radio or video player may cause poor picture and sound quality. In that case, move the DVD player further from television set, radio or video player.

Condensation

Condensation may occur in the following cases:

- When the DVD player is moved directly from a cold to a warm place.
- When the DVD player is used in a room where the radiator has just been switched on or where the cold air from the air condition plant is directed at the device.
- If the DVD player is used in the summer in a warm and humid room just after it has been removed from an air conditioned room.
- If there is steam or a high level of humidity in the room.

In case of condensation, the DVD player will not work properly. Remove the disc and turn off the device. Unplug the device and leave it for 2-3 hours. The DVD player will then have adapted to the environment and any condensation will have disappeared.

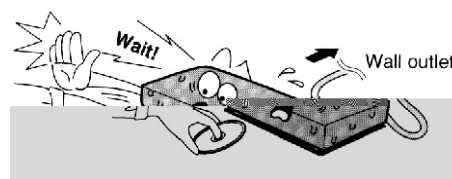
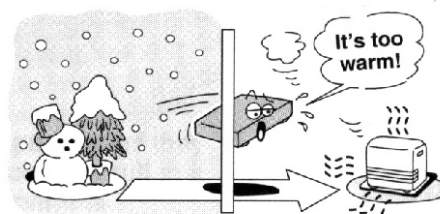

NOTE:

An Ø may appear on the screen when the device is turned on. This means that the required operation is not available.

le a R

ving di

D AUDIO

IO CD

HDI

,E



Disc Protection

Disc handling

- Do not touch the playback side of the disc
- Do not put paper or tape on the disc

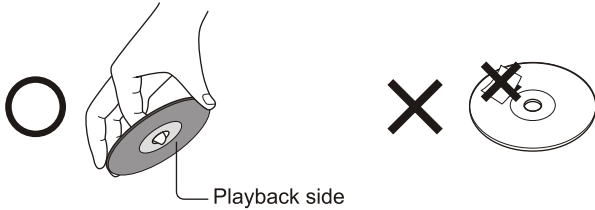

Cleaning the discs

- Finger prints and dust may cause poor sound and picture quality. Wipe the disc with a dry, soft cloth. Wipe from the centre out. The disc should always be clean.



- If the dust cannot be removed with a soft cloth, wipe the disc carefully with a moist cloth and then with a dry cloth.
- Do not use any type of solvents such as thinner, petrol, commercial detergents and anti-static spray for vinyl records. These may damage the disc.

Storing the discs

- Do not store the discs where they may be exposed to direct sunlight or where they are close to sources of heat.
- Do not store the discs where they may be exposed to moist or dust, for example in a bathroom or close to a humidifier.
- Store the discs standing in a cassette. If the cassettes are stacked or an object is placed on the cassettes, the discs may become uneven.

Organisation of discs

Normally, DVD discs are divided into titles, and the titles are then divided into chapters. Music CDs are divided into tracks.

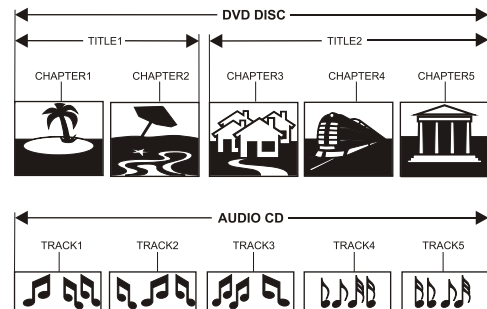

Each title, chapter and track has been given a number, designated title number, chapter number and track number, respectively.

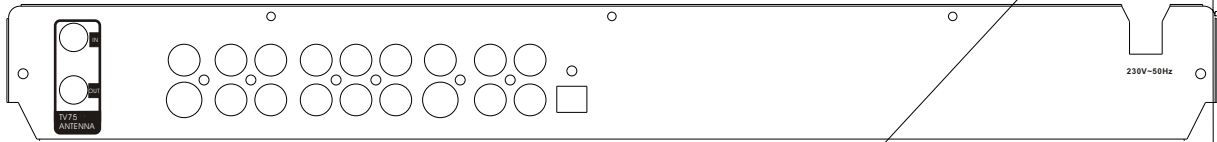

Identification of Controls

REMOTE CONTROL

THE INSTRUCTIONS BELOW DESCRIBE THE FUNCTIONS OF THE REMOTE CONTROL

1. OPEN/CLOSE
2. DV
3. TV
4. NUMBERS
5. SETUP
6. DIRECTION
(UP/DOWN/LEFT/RIGHT)
7. SELECT
8. MENU
9. TIMER
10. REC/OTR
(RECORD/ONE-TOUCH RECORD)
11. PLAY
12. STOP
13. REVERSE
14. PREVIOUS
15. FWD
16. NEXT
17. AUDIO
18. SUBTITLE
19. REPEAT
20. SLOW
21. PROG
22. RANDOM
23. STANDBY/ON
24. SCAN
25. AV(SOURCE)
26. NAVIGATION
(UP/DOWN/LEFT/RIGHT)
27. ADD/CLEAR
28. TITLE
29. DISCOVER ATION
30. EDIT
31. MUTE
32. PAUSE/STEP
33. VOLUME+
34. CHANNEL+
35. VOLUME-
36. CHANNEL-
37. RETURN
38. ANGEL
39. DISPLAY
40. ZOOM
41. GOTO
42. PS/IS(PROGRESSIVE / INTERLACE SCAN)

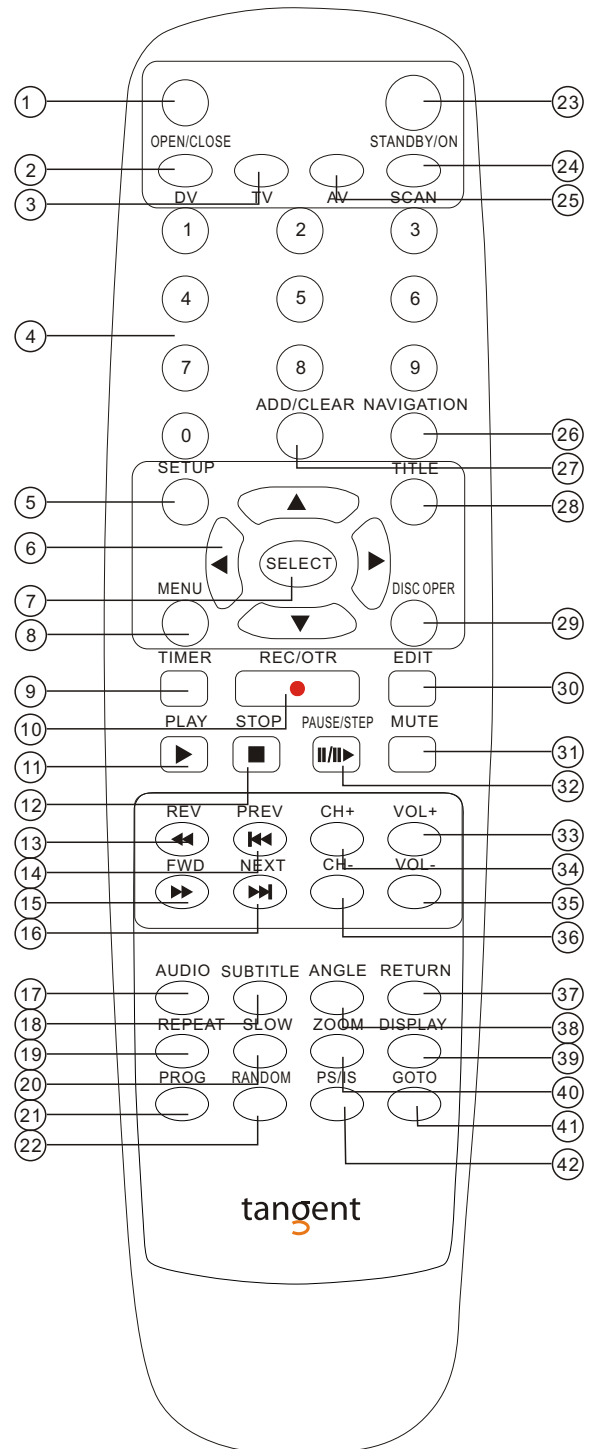

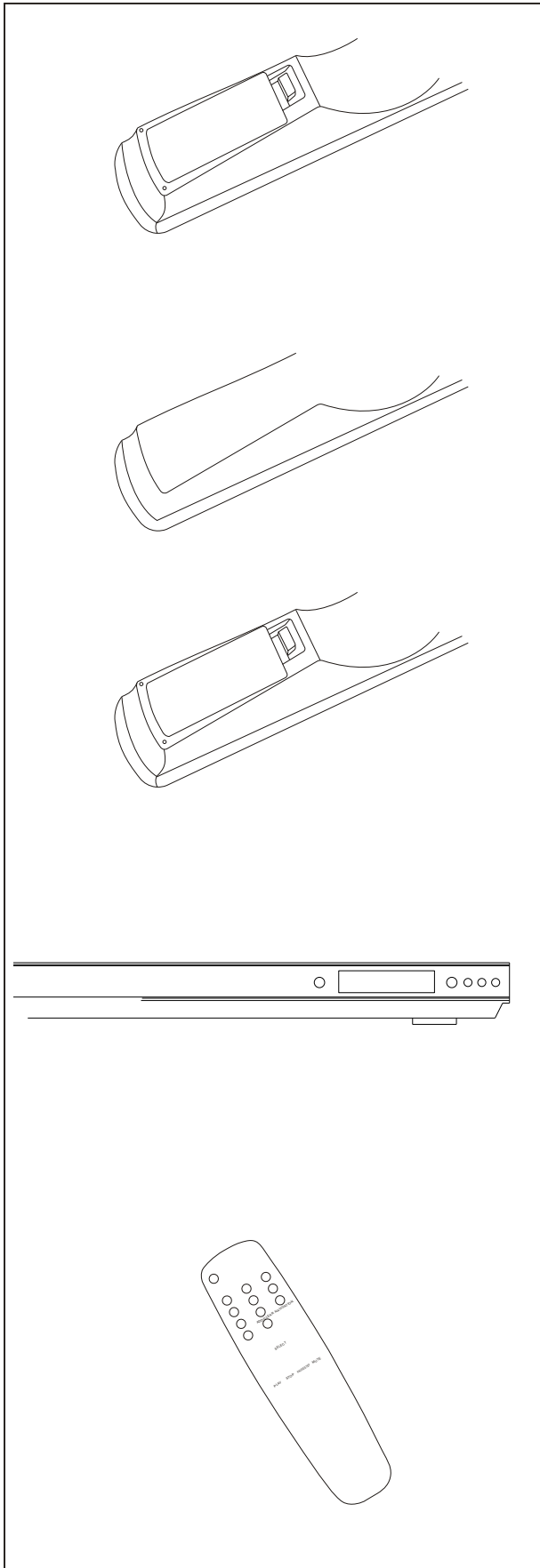

Battery Installation

1. Push downward and outward the leaf spring to remove the battery compartment cover.
2. Insert two size AA batteries according to the "+" and "-" markings.
3. Make sure the batteries have been properly installed, then close the battery compartment cover.

Notes:

Do not mix different types together, or old batteries with new batteries.

While the remote controller will not be used for an extended period of time, remove the batteries to prevent possible corrosion.

To prevent corrosion resulting in damage, remove exhausted batteries immediately. Where the remote controller doesn't appear to operate normally, replace both of the batteries.

Typical life for the batteries provided with this product is about 6 months. The life expectancy may vary according to the use status.

Use of the remote controller

Point the remote controller toward the remote sensor on your DVD home theater center. Upon receipt of the signal from the remote controller, the equipment will operate accordingly.

The description in this Manual is based on the buttons on the equipment. You may use the counterparts on the remote controller to do the same.

Notes:

Do not place this equipment in a place exposed to direct sunlight or strong light source like inverting fluorescent light, or else it may interfere with correct operation of the remote controller.

When other similar remote controller is used in the same room, or when this product is used near other equipment using infrared ray, interference with the operation of this remote controller may occur.

Do not place any object on the remote controller, or else it may cause unintentional depression of the buttons and waste the batteries unnecessarily.

The front of the chassis should not be glazed with color glass, or else it may cause interference with normal operation of the remote controller.

Any barrier between the remote controller and remote sensor will inactivate any operation of the remote controller.

The operating range between the remote controller and the equipment shall be no more than 5 meters (16 inches). When the operating range becomes shorter, replace the batteries with new ones.

Connection

CONNECTION FOR AUDIO OUTPUT

Dolby Pro Logic Surround Sound (GOOD)

Enjoy Dolby Pro Logic Surround by connecting an amplifier and speaker system (right and left front speakers, a center speaker, and one or two rear speakers).

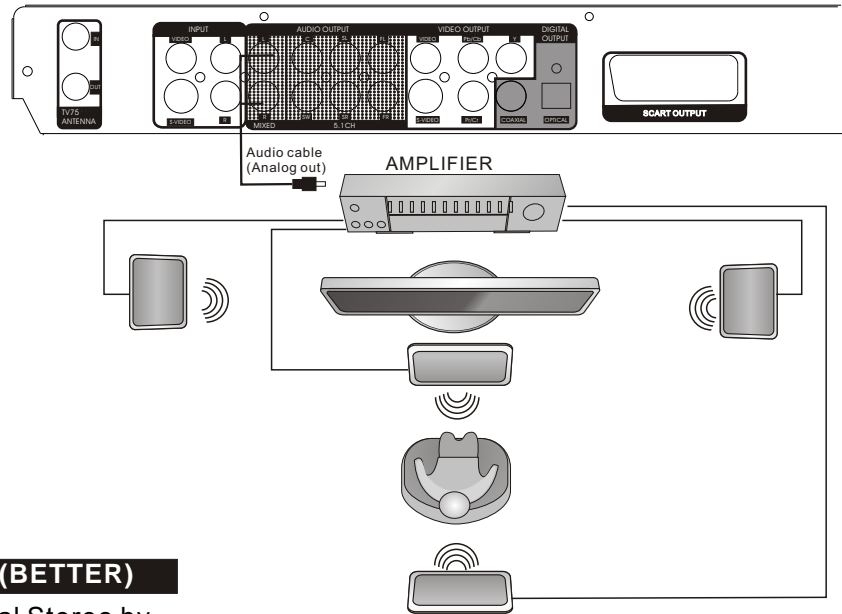

Enjoying Digital Stereo Sound (BETTER)

Enjoy the dynamic sound of Digital Stereo by connecting an amplifier equipped with a digital audio input and speaker system (right and left front speakers, a center speaker, and one subwoofer speaker, and two rear speakers)

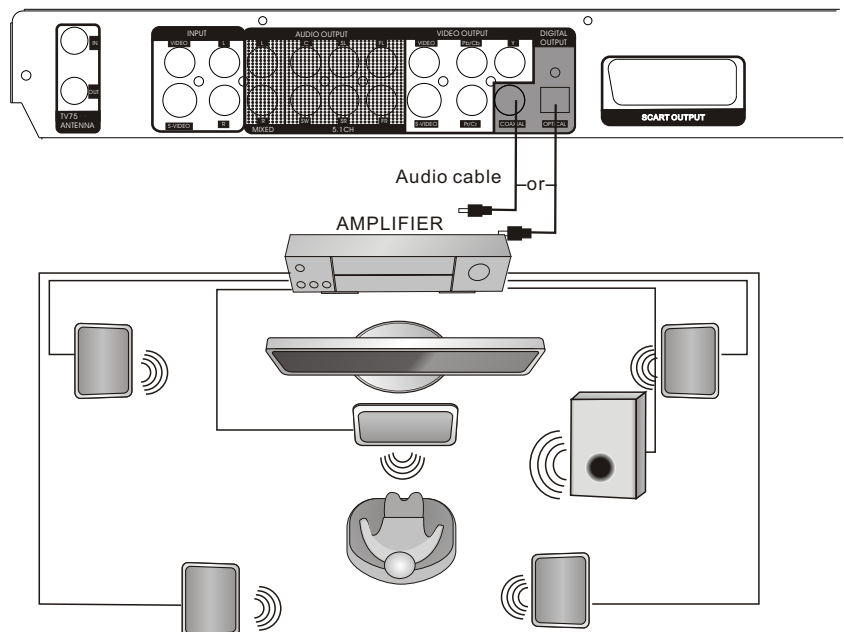

Connection

CONNECTION FOR VIDEO OUTPUT

GOOD

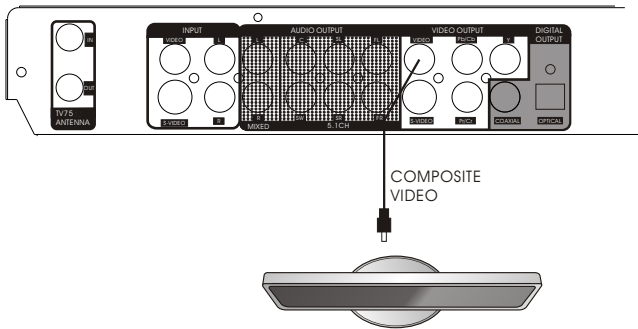

BETTER

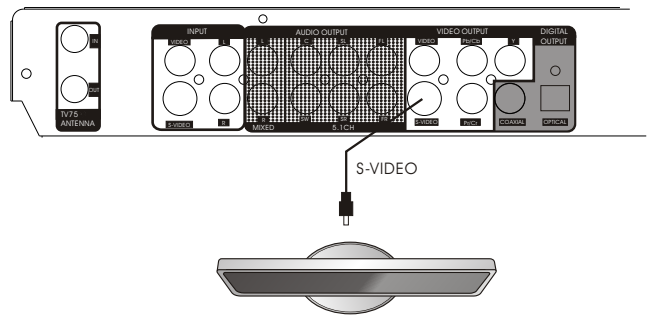

Connect your recorder with the S-Video cable, if the TV has an S-Video input. Do not connect the yellow video cable of using the S-Video cable.

SCART RGB VIDEO OUTPUT (BEST)

The SCART Video OUTPUTput allows you to enjoy the best picture quality from a DVD video disc.

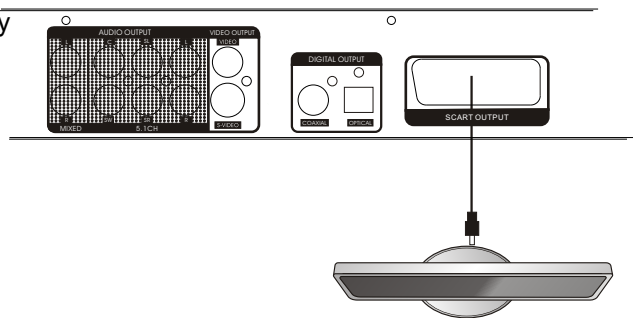

CONNECTION FOR TV TUNER

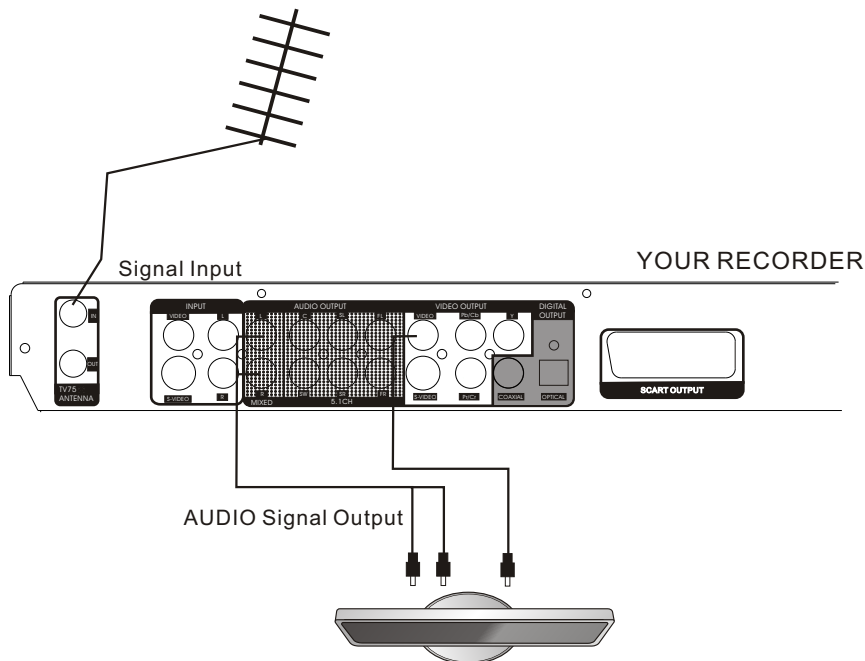

NOTE

- i Refer to the manual of the connected TV.
- i Turn off the power and unplug both units before setting up any connections.

Connection

CONNECTION FOR AV SIGNAL (A/V FRONT INPUT)

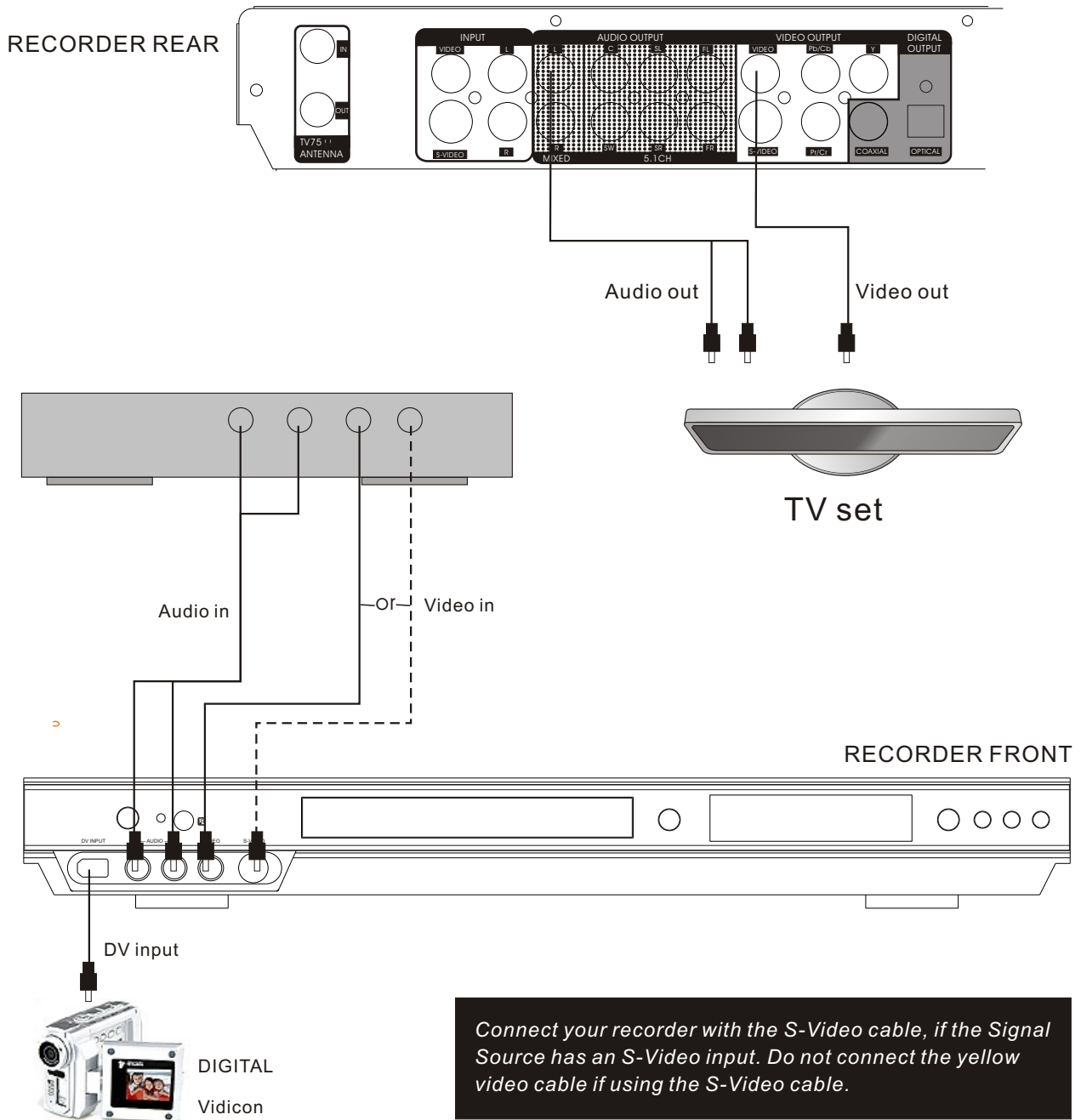

NOTE

- i Refer to the manual of the connected system.
- i Turn off the power and unplug both units before setting up any connections.

Mp3 & Progressive Scan

WHAT IS MP3?

MP3 refers to a new format of music files available for playback over the internet. The popularity of MP3 allows people to download music from MP3 websites onto ones home computer.

WHAT IS PROGRESSIVE SCAN?

Progressive Scan creates a picture with double the scan lines of traditional component video pictures and creates a sharper image. The advantages of progressive scan video output are reduced picture flickering and motion artifacts as well as a sharper image on large screens.

Playing Back a Disc

PLAYING A NORMAL DISC

1. Power on your recorder.
2. Insert a DVD disc.
3. Press direction Keys or the number buttons to select the title.

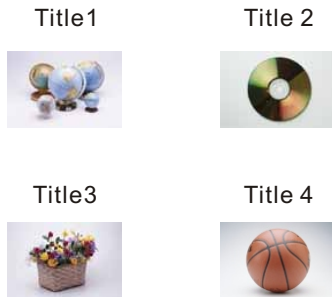

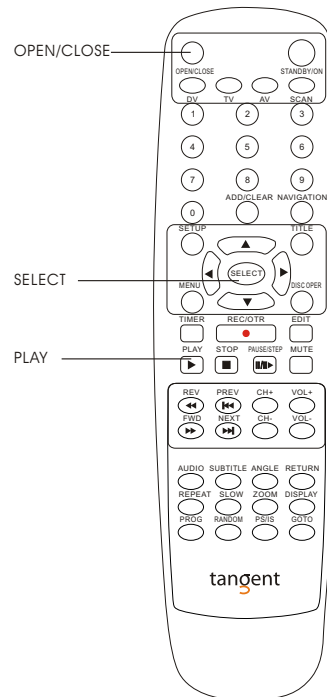

4. Press the **SELECT** or **PLAY** button.
The DVD video player will start playback from the title selected.
5. To remove the disc, press the **OPEN/CLOSE** button.



PLAYING A DVD+RW OR DVD+R DISC

Index Picture Screen

	1. TITLE 01/01/00 12:03:47 SP00:00:20
	1. TITLE 01/01/00 12:06:50 HQ00:00:20
	1. TITLE 01/01/00 12:08:57 SLP00:00:20



Description:

1. The name of the pre-recorded. The default is TITLE.
2. The date and time of the record.
3. Title time of the record.
4. The quality.
5. Length of the record

1. ___ 1. TITLE
2. ___ 01/01/00
3. ___ 12:03:47
4. ___ SP 00:00:20
5. ___

Playing Back a Disc

PLAYING A DVD+RW OR DVD+R DISC

- 1. Power on your recorder.**
- 2. Insert a DVD+RW or DVD+R disc**
The index pictures will appear on the screen.
- 3. Press the OPEN/CLOSE button**
To open or close the disc tray.
- 4. Use direction keys(UP/DOWN/RIGHT/LEFT) to highlight the item you desired.**
- 5. Press SELECT or PLAY.**
To select identified part of movie, or enjoy one(From the start).
- 6. Stop playback**
Press the STOP button once to freeze the imagine; press the **PLAY** button to resume .
If playback from the start, press the **STOP** button twice then press the **PLAY** button.

Note:

After finishing playback all titles contained on a DVD+RW or DVD+R disc, it will return to the Index Picture Screen.

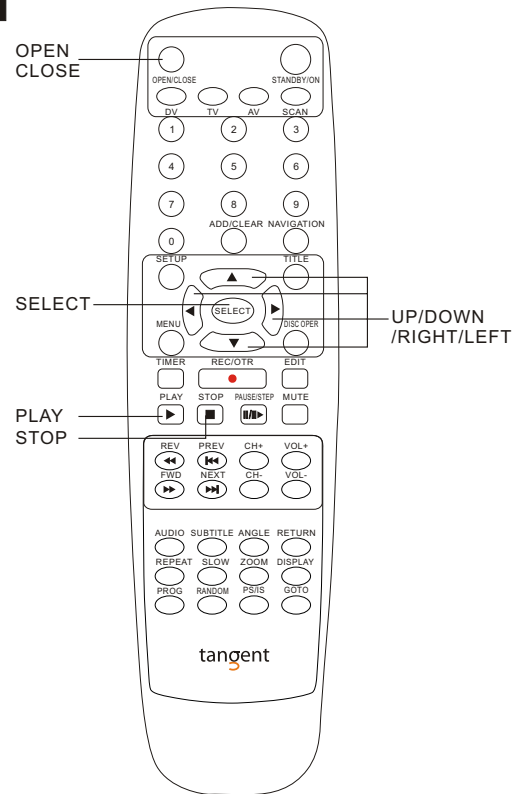

GENERAL FEATURES

All playback operation can be realized by the navigation. During playback, press DISPLAY button twice to access the control bar:

▶ DVD
MODE Normal ▶
TRICK Play
TITLE 35/41
CHAPTER 01/01
AUDIO 01/02-OTH
SUBTITLE Off
ANGLE 01/01
T-TIME 00:00:00-00:00:00

The details of every functions is as follows:

Press RIGHT/LEFT to highlight one icon and press SELECT to enter , after pressing UP/DOWN to select item, press SELECT.

Press DISPLAY again to cancel the control bar.

MODE Normal ▶

Playback mode Set your appreciated playback mode such as PROGRAM, RANDOM and various repeat mode.

TRICK Play

Playback control Control playback by various setting such as FAST FORWARD, FAST REVERSE, PAUSE, STOP, etc.

TITLE 35/41

Title Select to choose an available title by inputting numbers.

CHAPTER 01/01

Chapter Select to choose an Available chapter by inputting numbers.

AUDIO 01/02-OTH

Audio Select your desired audio setting, if Available.

SUBTITLE Off

Subtitle Select to choose anavailable subtitle by inputting Numbers.

ANGLE 01/01

Angle Select your desired camera angle, if Available.

T-TIME 00:00:00-00:00:00

Timer Goto the point you want to start from by inputting the time.

Playing Back a Disc

GENERAL FEATURES

1. Fast forward playback

Press >> during normal playback.

The speed will cycle with each press as: FF2, FF4, FF16, FF32 or play.

Press **PLAY** to resume normal playback.

2. Fast reverse playback

Press << during normal playback.

The speed will cycle with each press as: FB2, FB4, FB16, FB32 or play.

Press **PLAY** to resume normal playback.

3. Pause playback

Press **PAUSE/STEP** during normal playback to pause and press **PLAY** to resume normal playback.

4. Frame advance

Press **PAUSE/STEP** during normal playback.

One frame is advanced when pressing **PAUSE/STEP**.

Press **PLAY** to resume normal playback.

5. Slow

Press the **SLOW** button during playback

The playback speed becomes 1/2, 1/4, 1/8 of the normal speed or normal play when pressing the **SLOW** button.

Note:

The above features vary depending on the disc type such as MP3, Audio CD, etc.

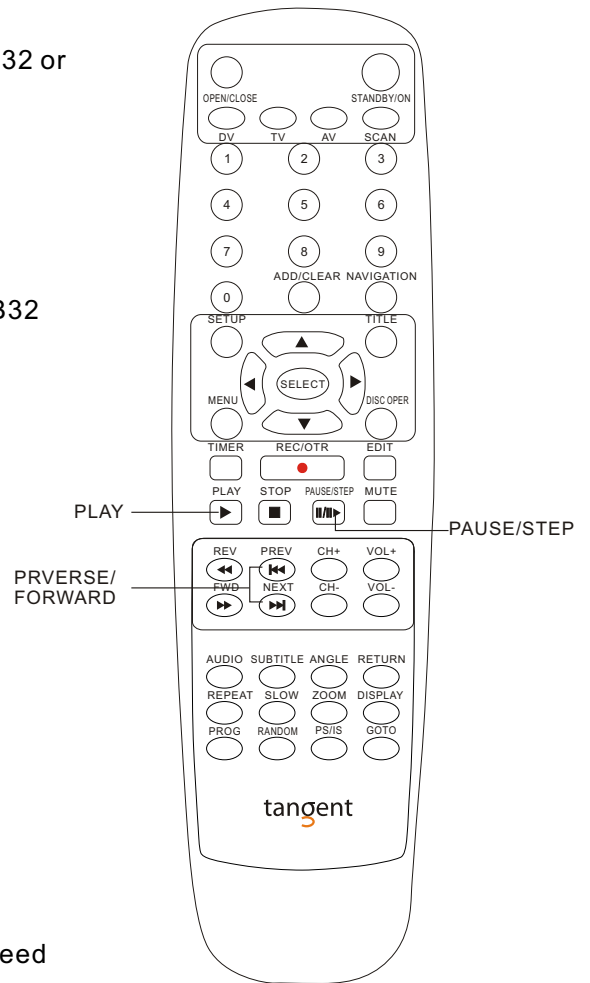

Locating a Specific Title, Chapter or Track

DVD VIDEO DISCS ARE NORMALLY DIVIDED INTO TITLES AND SUB-DIVIDED INTO CHAPTERS. SIMILARLY, CD'S (AUDIO, HDCD, and MP3) ARE DIVIDED INTO TRACKS. YOU CAN CONVENIENTLY LOCATE ANY SPECIFIC TITLE, CHAPTER, OR TRACK WITH THIS DVD PLAYER.

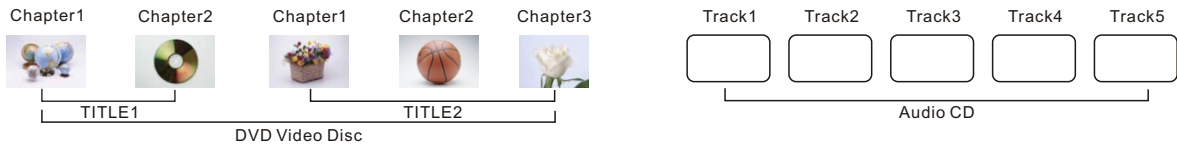

LOCATING A TITLE USING THE TITLE MENU

You can locate a specific title using the title menu function, if a DVD video disc contains a title menu.

1. Press the **TITLE** button
On the TV screen, the title menu will appear.
2. Press the **▲/▼/◀/▶** button to select the title you want
3. Press the **SELECT** button
This will cause the DVD video player to start playback from chapter 1 of the title selected.

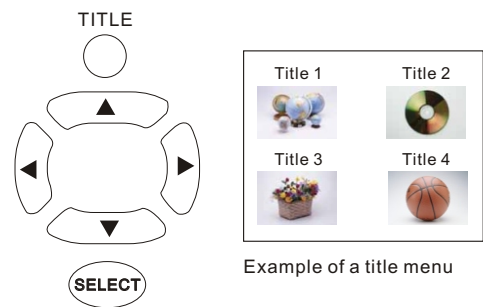

NOTICE

- There are some disc that does not respond to this function.
- If different instructions appear on the TV screen, follow those instructions. The instructions above are describe the basic procedure, but procedures may depend on the contents of the DVD video disc.

LOCATING A SPECIFIC CHAPTER OR TRACK

This player allows you to locate consecutive chapters or tracks.

Press the **SKIP I<< or >>I** button repeatedly to display the requested chapter or track

The player starts playback from the selected chapter or track.



How to locate proceeding chapters or tracks

When you press the **SKIP I<<** button, the player starts playback from the beginning of the preceding chapter or track.

How to locate succeeding chapters or tracks

When you press the **SKIP >>I** button, the player starts playback from the beginning of the succeeding chapter or track..

Notice: on some discs the titles may not display the sub-divided chapters.

Locating a Specific Title, Chapter or Track

LOCATING A TITLE

If a DVD video disc contains title numbers, you can locate a specific title by directly selecting a title number.

1. Press **GOTO** during playback.

The control bar will display on the screen.

▶ CHAPTER---

▶ TITLE:--

▶ TIME-: --:--

2. To select your desired Chapter, input the number of a vailable chapter, then press **SELECT** to confirm it.

e.g. To select Chapter2

▶ CHAPTER- -2

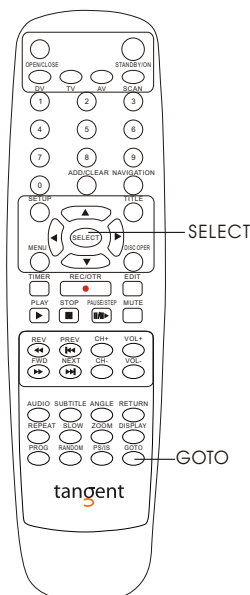

3. To select your desired title, press **GOTO** to highlight the icon ▶ TITLE:--

▶ TITLE:--

and input the number of a vailable title, then press **SELECT**.

4. If you want to start playback from some point, press **GOTO** to highlight the icon

▶ TIME-: --:--

, and input the time, then press **SELECT**.

Note:

- The function is invalid on MP3 disc.
- For CD disc, GOTO is used for track/time selection.

Playing Repeatedly

THIS RECORDER ALL ALLOWS YOU TO PLAYBACK A SPECIFIC TITLE, CHAPTER, TRACK, OR SEGMENT REPEATEDLY.(TITLE REPEAT, CHAPTER/TRACK REPEAT,A-B REPEAT)

HOW TO REPEAT A TITLE, CHAPTER, OR TRACK

1. Press the **REPEAT** button during playback.
The repeat mode changes, each time you press the **REPEAT** Button.

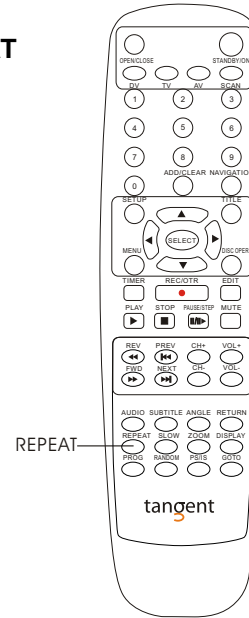
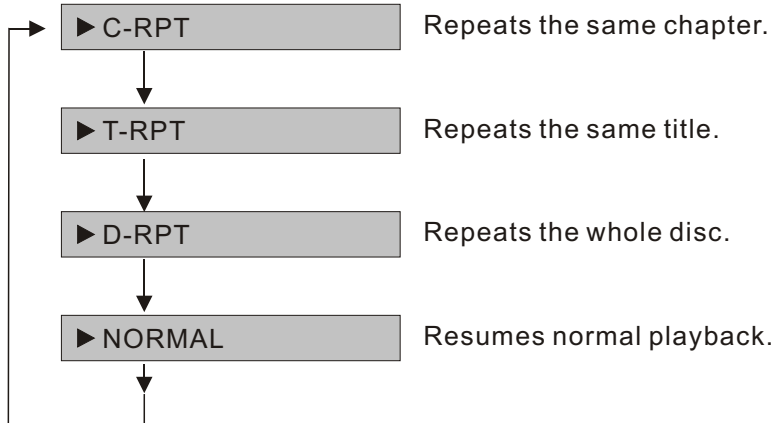

HOW TO REPEAT A SPECIFIC SEGMENT

1. Press **DISPLAY** button twice to access the control bar.
2. Highlight **MODE Normal** by pressing **RIGHT/LEFT**, press **SELECT**.
3. Use **UP/DOWN** to select **A-B Repeat** and press **SELECT** at the beginning of the segment in which you want to repeat playback(point A).
4. Press **SELECT** again at the end of the segment(point B)
The player will automatically return to point A and Start to repeat playback to the selected segment(A-B)

▶ DVD		
MODE	Normal	Normal
TRICK	Play	A-B Repeat
TITLE	35/41	Chapter Repeat
CHAPTER	01/01	Title-Repeat
AUDIO	01/02-OTH	Disc Repeat
SUBTITLE	Off	
ANGLE	01/01	
T-TIME	00:00:00-00:00:00	

5. Highlight **MODE A-B Repeat** by pressing **RIGHT/LEFT**, press **SELECT**.
Use **UP/DOWN** to select **NORMAL** and press **SELECT** to resume normal playback.

Note:

- There are two repeat modes for MP3/CD disc. On CD disc, they are track repeat and disc repeat, and on MP3 disc, they are repeat song and repeat directory.

▶ VCD		
MODE	Normal	Normal
TRICK	Play	A-B Repeat
TRACK	01/01	Track-Repeat
AUDIO	Stereo	Disc-Repeat
PBC	PBC on	Program
TR-TIME	00:01:50-01:25:40	Random

Playing in Random Order

THIS RECORDER ALLOWS YOU TO PLAYBACK TITLES, CHAPTERS WITHIN A TITLE, OR TRACKS IN RANDOM ORDER.

PLAYING TITLES IN RANDOM ORDER

1. During normal playback press the RANDOM button.
The player will start random playback now.

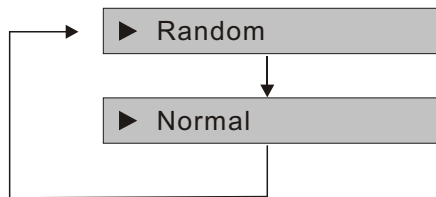

2. Press RANDOM again to resume normal playback.

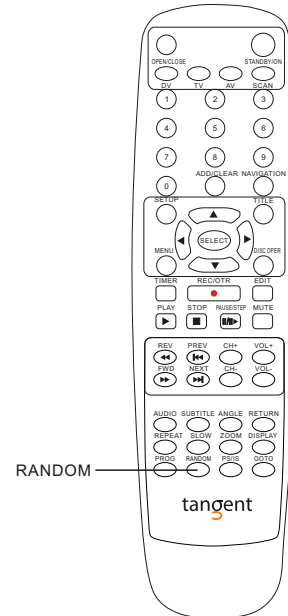

Note:

- The player will go to another chapter or track and start playback, if you press the SKIP button >>I, I<< , during random playback.

This player allows you to select a preferred language and sound recording system from those included on the DVD video disc.

- 1. Press the AUDIO button during playback**
- 2. Press the AUDIO button repeatedly to cycle through the options**

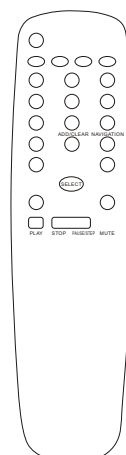

Playing in a Favorite Order

THIS PLAYER ALLOWS YOU TO PROGRAM UP TO 99 ITEMS INTO MEMORY AND THEN PLAY THEM BACK IN THAT ORDER. (PROGRAM/PLAYBACK)

HOW TO SET TITLES, CHAPTERS, OR TRACKS IN A FAVORITE ORDER

1. Press **DISPLAY** button twice to access the control bar.

2. Highlight **MODE** Normal by pressing **RIGHT/LEFT**, press **SELECT**.

3. Use **UP/DOWN** to select **PROGRAM** and press **SELECT**, two volumes will appear on the screen.

- The left volume displays all titles on the disc.

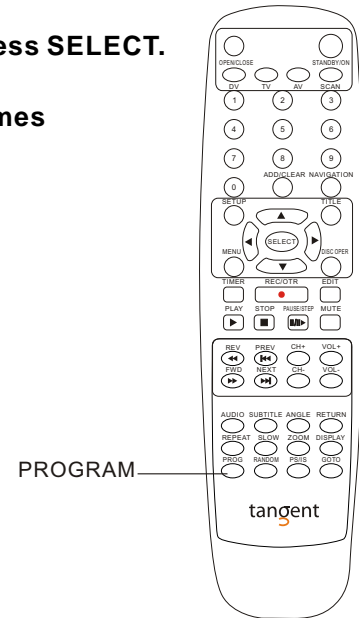
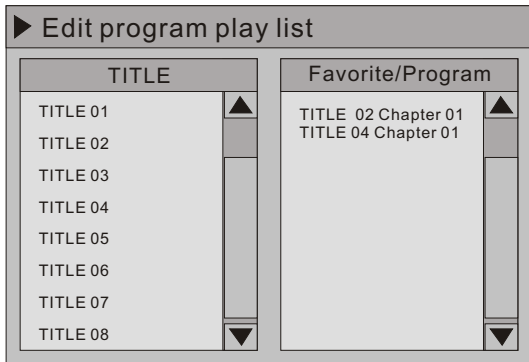

- The right volume allows you to edit titles in your favorite order.

2. In the left volume, use **UP/DOWN** to select one title, and press **ADD/CLEAR** to add it to the right volume.

You can also select one chapter by pressing **SELECT** after highlighting the title.

3. To clear one title you have added in the right volume, highlight the one and then press **ADD/CLEAR** to clear it. Use **RIGHT/LEFT** to move the cursor between the volumes.

4. Press **PROG** to return the **PROGRAM** playback.

5. Press **DISCPLAY** button twice to access the control bar
Select **MODE** Program use **UP/DOWN** to select **NORMAL** and press **SELECT** to resume normal playback.

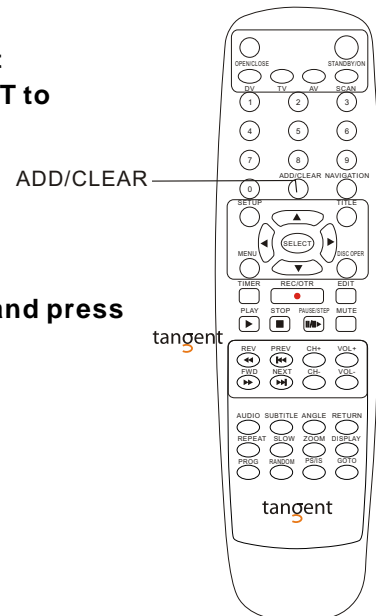

Note:

- On the MP3/CD disc, there are some differences on OSD.

Selecting Subtitles

THIS RECORDER ALLOWS YOU TO DISPLAY THE SUBTITLES FROM THOSE INCLUDED ON THE DISC ON TO YOUR TV SCREEN.



HOW TO DISPLAY SUBTITLES

Press the SUBTITLE button during playback to choose one of the subtitles available on the disc, or turn the subtitle off.

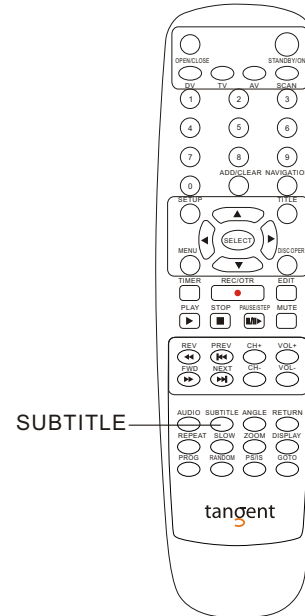
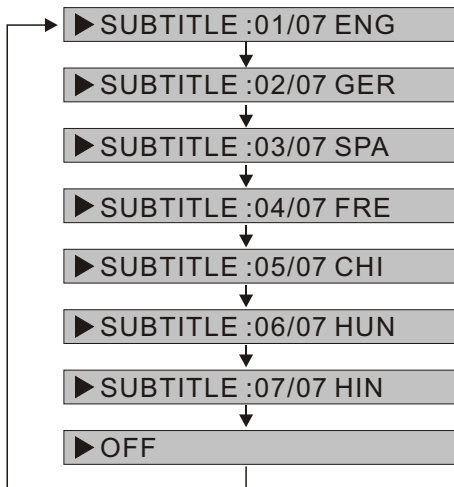

Note:

- Due to the nature of some DVD's, you may not be able to turn off the subtitles as they will appear on screen automatically.
- As you press the SUBTITLE button, the subtitles may not appear immediately during some scenes.
- If the subtitles continue to show on your TV even after the DVD has been turned off, please check the closed caption settings on your TV.

Using the On-Screen Display

THIS PLAYER ALLOWS YOU TO VIEW STATUS AND DISC INFORMATION ON YOUR TV SCREEN.

CHECKING THE OPERATIONAL STATUS

With this function, you can view on your TV the following informations:

- Play back status
- Current title
- Current chapter
- Current language
- Current title Time

Press **DISPLAY** button during DVD playback.

▶ Normal Play T01/25 C06/21 AU01/03 00:26:48

→ PLAY BACK STATUS

▶ Normal Play T01/25 C06/21 AU01/03 00:26:48

→ CURRENT TITLE/TOTAL TITLE

▶ Normal Play T01/25 C06/21 AU01/03 00:26:48

→ CURRENT CHAPTER/TOTAL CHAPTER

▶ Normal Play T01/25 C06/21 AU01/03 00:26:48

→ CURRENT LANGUAGE

▶ Normal Play T01/25 C06/21 AU01/03 00:26:48

→ CURRENT TITLE TIME

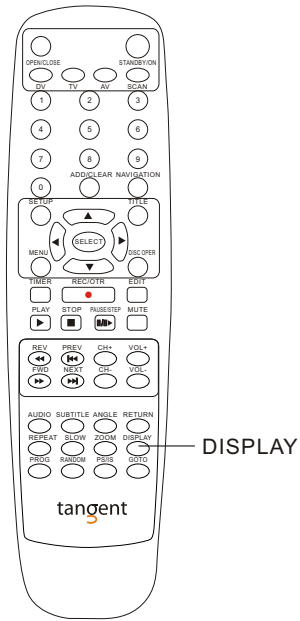

Setting the Parental Lock

YOU CAN USE THE PARENTAL LOCK FUNCTION ONLY WITH DVD EQUIPPED WITH THE PARENTAL LOCK FEATURE

SETTING THE PARENTAL LOCK

DVD equipped with the parental lock function is rated according to their content. The contents allowed by a parental lock level and the way a DVD can be controlled may vary from disc to disc. For example, if the disc allows it, you could edit out violent scenes unsuitable for children and replace them with more suitable scenes, or lock out playback of the disc all together.

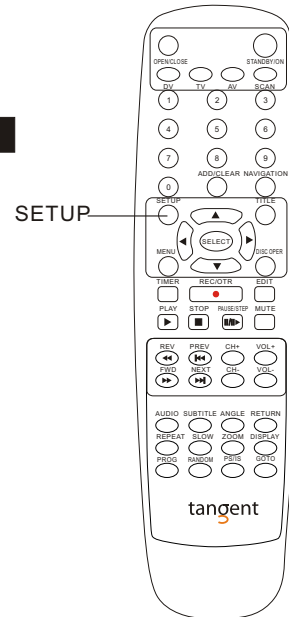

1. Press **STOP** button twice during playback.
2. Press **SETUP** during stop status.
3. Highlight the **PLAY** icon by pressing **RIGHT/LEFT**.
The menu appears on the TV screen.

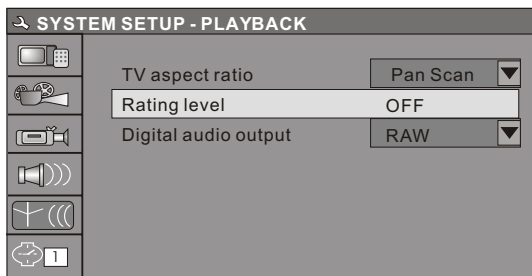

4. Use **UP/DOWN** to select Rating Level, press **SELECT** button.
5. Input your password of numbers, highlight **OK** and press **SELECT**.

The pre-set password is 3308

6. Press **SELECT**, the sub-menu of Set Rating Level appears, use **UP/DOWN** to select one rating, press **SELECT** to confirm it.

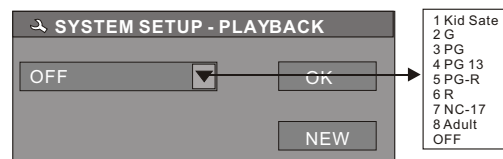

7. Highlight **OK** and press **SELECT** to save your setting.
8. Press **SETUP** button to exit setup, press **PLAY** button to start

TO CHANGE YOUR PASSWORD:

1. Follow step 1-6 to select "New".
2. Enter new password.
3. Re-enter to confirm your new password.
5. Highlight **OK** and press **SELECT** to save it.
6. Press **SETUP** button to exit.

Customizing Function Settings

THIS PLAYER ALLOWS YOU TO CUSTOMIZE THE PERFORMANCE TO YOUR PERSONAL PREFERENCES.

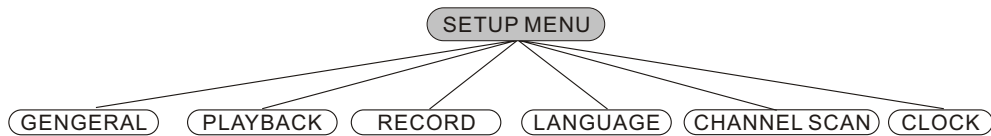

DISPLAYING THE SETUP MENU SCREEN

The SETUP MENU screen asks you to select a setting category from General, Speaker, Audio and Preferences. The selected category will provide you the setting details using the succeeding screen.

Main Page		
GENGERAL	General Setup	
	screen saver	On/Off
	Scart output	CVBS/RGB
	Video output format	PAL/NTSC
	Restore factory settings	OK
PLAYBACK	Playback Setup	
	TV aspect ratio	16:9/Pan Scan/Letter box
	Rating level	Off
	Digital audio output	RAM/LPCM
	Closed captions	ON/OFF
RECORD	Record Setup	
	Audio chapter market	On/Off
	Default source	F-CS/ F-SV/ RE-CS / RE-SV/ DV/TUNER
	Default quality	SLP/EP/SP/HQ
LANGUAGE	Language Setup	
	OSD language	English/Spanish/.....
	Menu language	English/Chinese/...../Original
	Subtitle language	Off/English/Chinese/...../Original
	Audio language	English/Chinese/...../Original
CHANNEL SCAN	Details see page 26	
CLOCK	Date& Time Setup	
	Date(mm/dd/yy)	01/01/00
	Time(hh:mm:ss)	01:15:01

1. Press **SETUP** during stopstatus.
2. Press direction keys(**UP/DOWN/RIGHT/LEFT**) to select category (highlight), then press **SELECT**.
3. Press **SETUP** to exit the setup menu.

Recording Options

CHANNEL SEARCH

To record TV programs, you should search TV channels first.

1. Press **SCAN** to access the TV setup menu.
2. Use the **UP/DOWN** button to highlight **SCAN** and press **SELECT**.
It will search channels automatically.
During auto-searching, press **STOP** to cancel searching.
3. To browse the found channels, use the **UP/DOWN** button to highlight **EDIT** and press **SELECT** to setup it, press **UP/DOWN** to Name, and you can also input numbers and press **SELECT**.
In the SKIP column, The channel cannot be found will be "YES".
4. If you want to skip one channel, select the corresponding channel. use **UP/DOWN** button to highlight the skip and press **SELECT**, press **UP/DOWN** to highlight the yes, and press **SELECT**,
5. use **UP/DOWN** to highlight the **OK** and press **SELECT**.
6. Press **SETUP** again to exit.

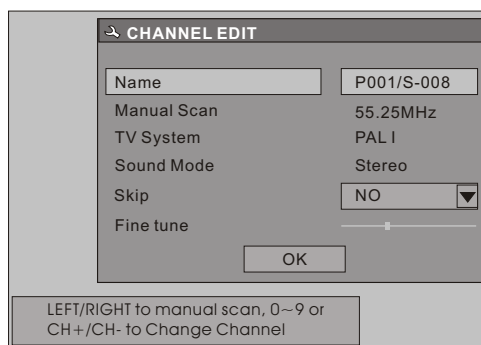
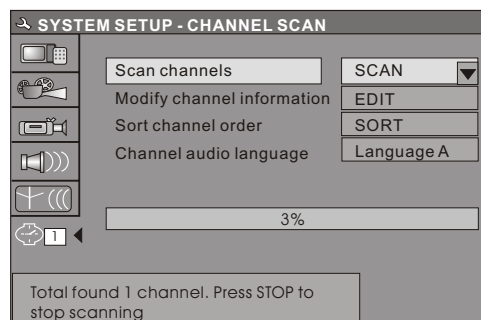

SETUP RECORD QUALITY

1. Press **SETUP** during stop status.
2. Press direction keys (**UP/DOW/RIGHT/LEFT**) to select.
3. Select default quality.

HQ: Perfect quality, nearly 60 minutes in a blank disc

SP: Standard play quality, nearly 120 minutes in a blank disc

EP: Extend play, nearly 240 minutes in a blank disc

SLP: Standard long play, nearly 360 minutes in a blank disc

NORMAL RECORDING

1. Make connections illustrated as page11 -14.
2. Insert a recordable **DVD+RW** or **DVD+R** into the recorder.
3. Press **DV. TV** or **AV** to select the input source which you have connected as step 1.
 - F-A/V: Front Audio/Video Input (on the front panel)
 - R-A/V: Rear Audio/Video Input (on the rear panel)
 - F-SV: Front S-Video (on the front panel)
 - R-SV: Rear S-Video (on the rear panel)
 - TV: (you can select it by pressing **CHANNEL+/-** or input the assigned number of the channel to select your desired one directly)
 - DV: Digital vidicon
4. Press **RECORD** to start recording.
If you want to stop recording, press **STOP**.
If the **DVD+RW** or **DVD+R** is new, it will take about three minutes to stop.

When is recording, press the **STOP** button the TV display postprocess please wait a moment .

Recording Options

ONE-TOUCH RECORD

1. During normal recording, press **RECORD**, the recorder will automatically stop in 30 minutes.
2. **The recording time will extend for another 30 minutes with each press.**
The length of recording time is determined by disc capacity and record quality.
With your setting, if it will exceed the capacity of the disc, OTR will be canceled, and switched to normal record.
3. If you want to stop recording, press **STOP**.

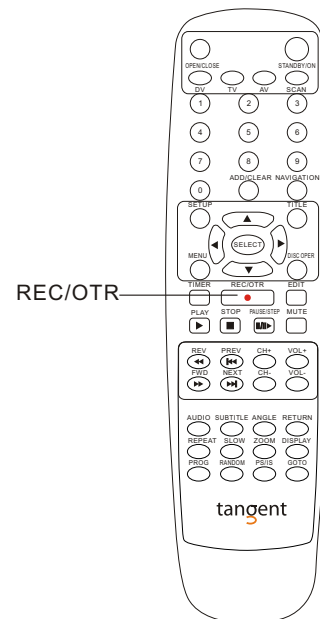

HOW TO SWITCH TO PLAYBACK MODE

When the recording is suspended, you can press **PLAY** to switch to normal playback mode.

CLOCK SETUP

1. During stop status, press **SETUP** to access the Setup Menu.
2. Use **RIGHT/LEFT** to highlight the **CLOCK** icon as the right figure.
3. With “Date (mm/dd/yy)” highlighted, press **SELECT**, and input the local date by numbers, press **SELECT** again.
4. With “Time (hh:mm:ss)” highlighted, press **SELECT**, and input the local time of numbers, press **SELECT** again.

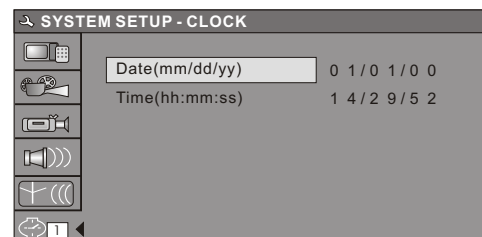

Note:

If you want to cancel, press **RETURN**.

Recording Options

TIMER RECORD

1. First setup the clock of your system as "CLOCK SETUP" on page 30.
It is recommended to setup your local date and time.

2. Press **TIMER**, the record scheduler will pop up.

Record scheduler						
	Source	Quality	Date	Start	End	
(W)	1	DV	SP	12/01/03	14:41	15:11
(W)	2	Rear CVBS	SP	DAILY	07:03	08:33
(W)	3	Ch057	HQ	12/31/03	12:44	13:05
	4					
	5					
	6					

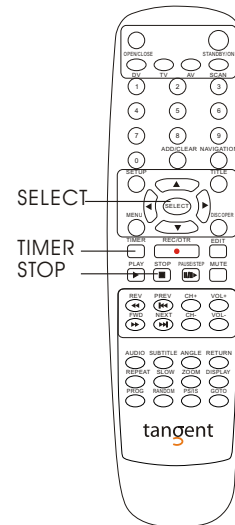

Note:

- If you want to delete a schedule, highlight the one, press **ADD/CLEAR**.

2. Use **UP/DOWN** to select one schedule, and press **SELECT** to access Item Editor as below:
In each item you can also use direction keys to highlight and press **SELECT** to choose Your

Signal input source, details see page 29, step 3.

Record frequency, once, daily or weekly.

Mm/dd/yy

Start time for recording

End time for recording

Record quality, details see

page 29 setup record quality.

Item Editor	
Source	DV
ONCE	0 1/0 1/0 0
Start	14 : 41
End	15 : 11
Quality	SP
<input type="button" value="Confirm"/> <input type="button" value="Cancel"/>	

3. Select and Confirm to save your setting.

4. In five minutes before it is ready to record the scheduled, it appears a Record Prompt dialog, affirm press **Confirm**, abolish press **CANCEL**, and if without operation for a moment it will record the scheduled automatically.

Note:

- In standby mode, your recorder can wake up in 2 minutes before recording.
- During recording, you can press **STOP** to suspend the recording.
- A DVD+RW/DVD+R can record for upto 360 minutes.

EDITING A TITLE OF DVD+RW

1. **Insert a recorded DVD+RW on the disc tray.**
The Index Picture screen pops up.
2. **Use the direction keys to highlight the title which you want to edit.**
3. **Press EDIT, the edit bar appears on the screen while playing back.**
Press RIGHT/LEFT to highlight one icon and enter it, press UP/DOWN to select a sub-item.

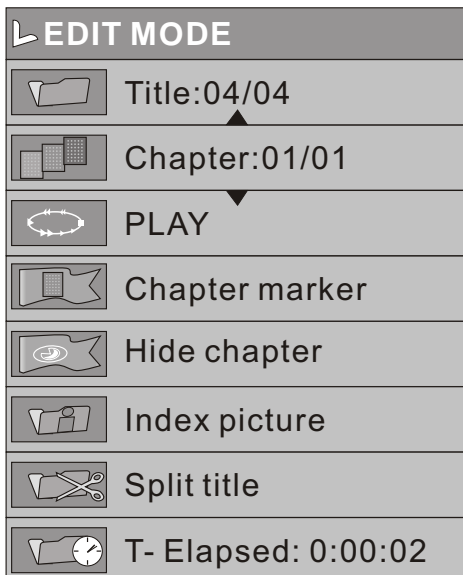

View current title/total title

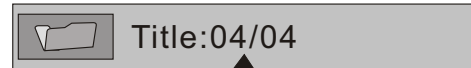

View current chapter/total chapter

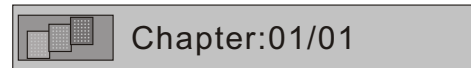

Current operation status



Chapter editing Select to add one chapter, or delete the current/all chapters, details see the next page.

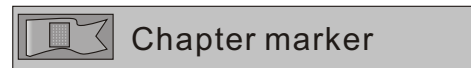

Chapter hide or unhide Select to hide the current page chapter,, details see the next page

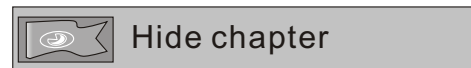

Title face or Title name Select to set the current image played back to the face of the title or select to name the current title, details see the next page.



Divide current to 2 titles at current point



Title Timer

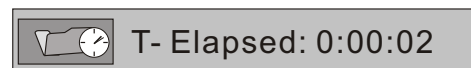

4. **Press EDIT to quit the menu.**

Editing

CHAPTER EDITING

From the control bar, select the fourth icon, press **SELECT** repeatedly, it will cycle as following:



When **Insert marker** is selected by pressing **SELECT**, a new chapter marker will be added to the current point.

When **Delete marker** is selected by pressing **SELECT**, the marker of the current chapter will be deleted.

When **Delete all markers** is selected by pressing **SELECT**, all of the chapter markers will be deleted.

Note:

From the second icon in the control bar, the above operation can be viewed.

If only one chapter is available in the current title, there is only **Insert marker** to select.

CHAPTER HIDE OR UNHIDE

From the control bar, select the fifth icon, press **SELECT**.

When the icon displays  **Hide chapter**, it shows the current chapter is visible, and you can select it to hide it by pressing **SELECT**.

When the icon displays  **Unhide chapter**, it shows the current chapter is invisible, and you can select it to unhide it by pressing **SELECT**.

Editing

TITLE ICON AND SPLIT TITLE

From the control bar, select the sixth icon, press **SELECT** .

When you want to set the current frame as the icon of the current title which miniature picture will appear in the Index Picture Screen, Press **SELECT** with  Index picture displayed.

From the control bar, select the seventh icon, press **SELECT** .

When  Split title is selected by pressing **SELECT**, a new title marker will be added to the current point.

EDIT TITLE NAME

1. Insert a recorded DVD+RW on the disc tray.
The Index Picture screen pops up.
2. Use the direction keys to highlight the title which you want to edit.
3. Press **RIGHT**, the edit bar appears on the screen while playing back.
Press **UP/DOWN** to highlight one icon and **SELECT** it.
4. From the control bar, select the fourth icon, press **SELECT** .
On the screen, there appears a keyboard:

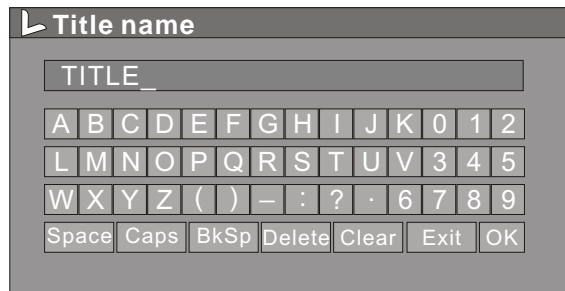
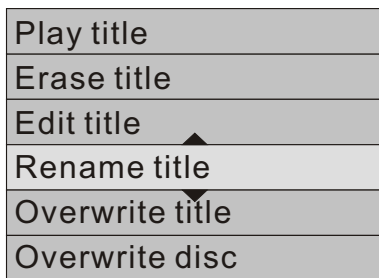

Press the direction keys (**UP/DOWN/RIGHT/LEFT**) to highlight the one which you want to input, and press **SELECT** to confirm it.

The control bars of the last line in the keyboard is for editing command.

Select **OK** to save the name.

Note:

The maximum length of the title name is up to 9 characters.

Editing

EDITING A DISC OF A DVD+RW

1. Insert a DVD+RW on the disc tray.
2. Press **DISC OPER** to access the disc editing menu.
3. With each icon highlighted by pressing **UP/DOWN**, the corresponding description of each operation will display on the screen, such as **Erase disc**, **Rename disc**, **Record a new title**, **Overwrite disc**, etc.
4. Press **SELECT** to run the operation.

DVD+RW Display

Play
Erase disc
Rename disc
Make compatible
Record a new title
Overwrite disc
Lock disc

DVD+R Display

Play
Rename disc
Finalize disc
Record a new title

EDITING A DISC OF A DVD+RW OR DVD+R

Play

Press **SELECT** to playback from the disc.

Erase disc

ERASE (only DVD+RW)

Press **SELECT** to begin erasing.

Rename disc

Press the direction keys (**UP/DOWN/RIGHT/LEFT**) to highlight the one which you want to input, and press **SELECT** to confirm it.

The control bars of the last line in the keyboard is for edit command. Select **OK** to save the name.

Note:

The maximum length of the title name is up to 9 characters.



Make compatible

compatible(only DVD+RW)

It shows you can make your current disc compatible. If you want to make your disc compatible with the other DVD player. You should go on **COMPATIBLE** operation.

Lock disc

LOCK(only DVD+RW)

When the icon display **LOCK**, it shows you can lock your current disc. If you have locked Your disc, you can't make any changes any more except play it back, but you can unlock it by **UNLOCK**.

Finalize disc

Finalize(only DVD+R)

Highlight the icon and press **SELECT**. It will take a few minutes to finalize the disc.

Note:

If a DVD+R has been finalized, you can not record or edit DVD+R any more. If you want to make your disc compatible with the other DVD player, you should go on **FINALIZE** operation.

Specifications

DVD Player

TV System	NTSC/PAL
Compatible Discs	DVD+R, DVD, CD, DVD-R, DVD-RW, MP3, DVD+RW, CD-R, CD-RW
Recordable discs format	DVD+RW, DVR+R
Resolution Ratio	Greater Than 500 lines
Video S/N Ratio	65dB
Frequency Response	fs (96KHz/24bit) 4Hz - 44KHz: +/-2dB
Audio S/N Ratio	95dB
Degree of Distortion	<0.01%
D/A Converter	192KHz/24bit
Video Out	1Vp-p
S-Video Out	Y: 1Vp-p(75Ω) C: 0.3Vp-p(75 Ω);
Audio Out	2.0V 5.1 Channel, 2 Channel mixed
Digital Audio Output Connections	Optical, Coaxial YUV, SCART, CVBS, S-Video

Remote Control

Transmitter	Infrared Ray
Signal Range	Approximately 5m
Power Source	2 "AAA" Batteries

General

Power Supply	AC 230V 50Hz
Consumed Power	30W
Standby Power	<3W

Because its products are subject to continuous improvement, We reserves the right to modify product design and/or specifications without notice and without incurring any obligations.

Trouble shooting Guide

Check the following guide for a possible correction to a problem before contacting customer service.

SYMPTOMS AND CORRECTION

Symptom	Correction
No power	<ul style="list-style-type: none"> • Connect the power plug into the wall outlet securely.
No picture	<ul style="list-style-type: none"> • Verify the connection from the DVD video output to the TV video input. Then Switch TV to appropriate mode(video 1) • Connect the video cable into the jacks securely. Refer to your television owners manual.
No sound	<ul style="list-style-type: none"> • Connect the audio cables into the jacks securely. • Verify the connection from the DVD audio output to the TV or receiver audio input. Then switch to the appropriate source on the receiver. Refer to your Audio amplifier owners manual.
Black & White picture	<ul style="list-style-type: none"> • Damaged S connector (bent pin)
The playback picture Has occasional distortion	<ul style="list-style-type: none"> • A small amount of picture distortion may appear because of a poor quality video/sound transfer to disc. This is especially true of some discs Manufactured between 1997-1998. • Scratched disc
Brightness is unstable or noises are produced on playback pictures	<ul style="list-style-type: none"> • Connect the DVD player directly through the TV and not through any other source. What you're viewing is the effect of the copy protection circuitry Required on all DVD players. • If you don't have a video input on your TV, you must purchase an Therefore Adapter from your dealer.
The DVD video player does not start playback	<ul style="list-style-type: none"> • Place the disc with the graphics side up. • Place the disc on the disc tray correctly inside the guide. • Make sure the disc is free from scratches & fingerprints. • Press the SETUP button to turn off the menu screen. • Cancel the parental lock function or change the parental lock level. (The Pre-set password is 3308.) • Turn the power off then disconnect the power plug and reinsert it back into the wall. Retry again.
MP3 won't read disc or It skips	<ul style="list-style-type: none"> • Return disc as the software edition used may not be compatible with the player. Check web site for instruction. • Use new editions of software such as Voyetra Audiostation 4, Adaptec's "Easy CD Creator", NTI or Roxio's Toast Titanium. • Make sure MP3 file are not encoded with a variable bit rate such as provided by Real Networks.
The remote control does not work Properly	<ul style="list-style-type: none"> • Replace the batteries with new ones.
The recorder cannot record.	<ul style="list-style-type: none"> • The type of the disc is wrong, it's not a DVD+RW or DVD+R disc. • The disc is recorded full. • The disc (DVD+R,DVD+RW) is locked, it should be unlocked. • The DVD+R has been finilized.
Some keys do not work	<ul style="list-style-type: none"> • The type of the disc is wrong, it's not a DVD+RW or DVD+R disc. • The unit is in record mode or it is recording.
The image is distorted.	<ul style="list-style-type: none"> • The setup of interlaced or Progressive is wrong. • Press the I/P button to switch from each other.

tangent